

PASLANMAZ ÇELİK
ALIN ALINA KAYNAKLI & FLANŞLI
PNÖMATİK ON-OFF TANK DİP VANASI
TANK İÇİNE AÇILAN TİP

SERİ : 705

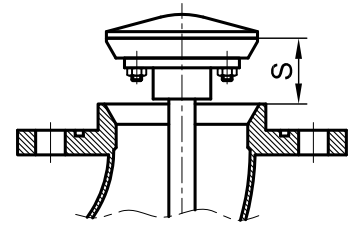
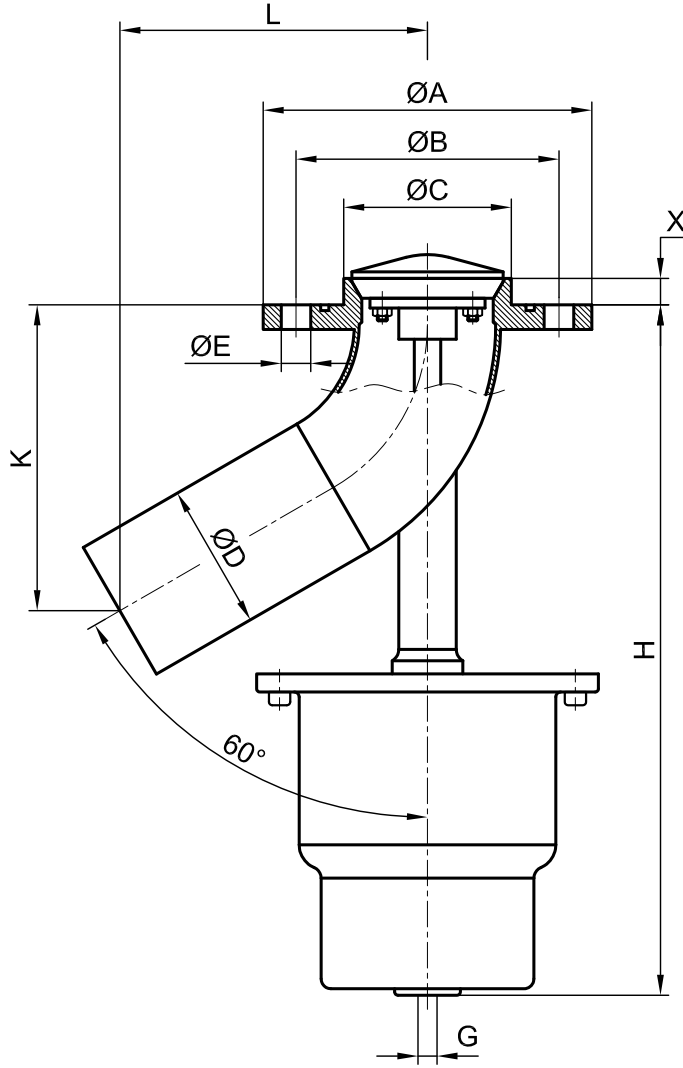

Strok pozisyonu

DN		PİSTON	Δp bar	ØA	ØB	ØC	ØD	ØE	Delik Sayısı	H	K	L	X	G	S
25	1"	Ø 100	8	115	85	50	33.7	14	4	245	87	97	14	G 1/8"	30
32	1 1/4"		8	140	100	57	42.4	18	4	255	100	110	14	G 1/8"	30
40	1 1/2"		6	150	110	60	48.3	18	4	290	108	115	14	G 1/8"	30
50	2"		6	165	125	75	60.3	18	4	310	125	125	14	G 1/8"	30
65	2 1/2"	Ø 150	6	185	145	85	76.1	18	4	400	165	173	16	G 1/4"	40
80	3"		6	200	160	102	88.9	18	8	420	181	178	16	G 1/4"	40
100	4"		4	220	180	122	114.3	18	8	455	207	185	16	G 1/4"	40
125	5"		4	250	210	152	139.7	18	8	490	237	200	16	G 1/4"	40
150	6"		4	285	240	177	168.3	22	8	525	265	210	16	G 1/4"	40

NOT : İstek halinde "X" yüksekliği farklı ölçüde yapılabilir. / Vakumlu uygulamalarda çift etkili aktüatör kullanılması önerilir.



ALFANOX

KT 705 A1